

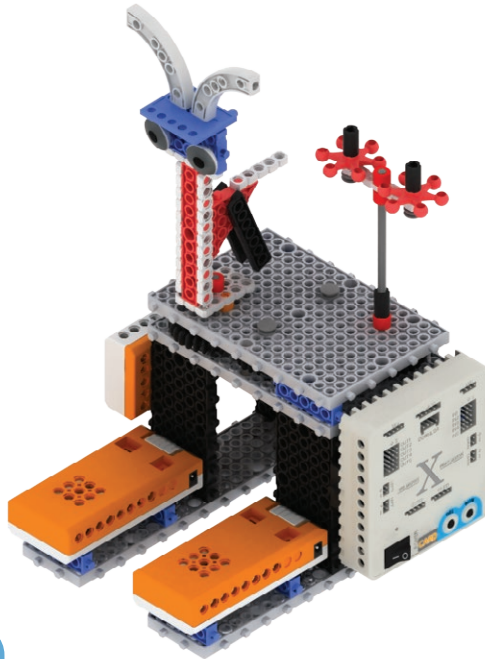

## 22 Dansator

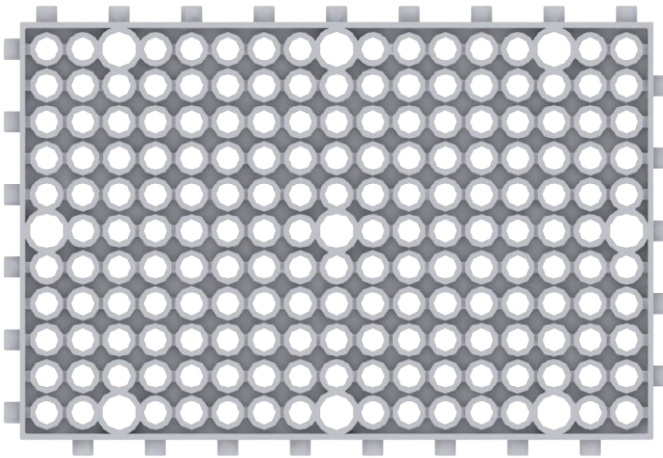

### Piese



Bloc 11x17 (2)

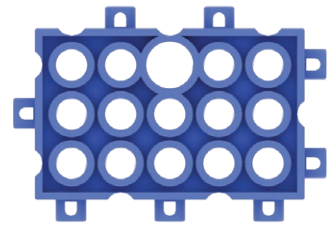

Bloc 3x5 (1)



Bloc N 3x5 (1)

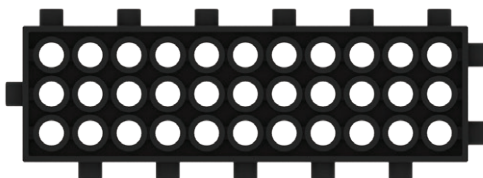

Bloc 3x11 (1)

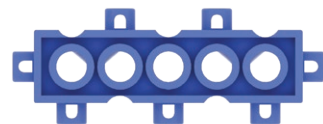

Bloc 1x5 (6)

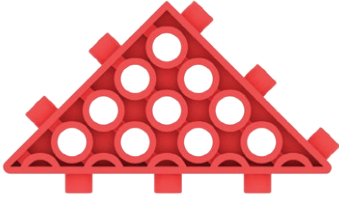

Bloc triunghiular



Bloc curbat (2)



Angrenaj simplu (2)

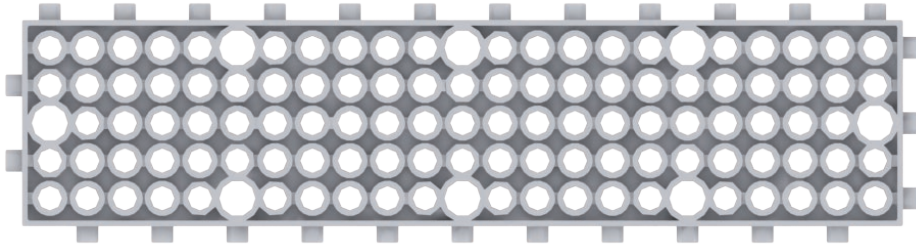

Bloc 5x23 (2)

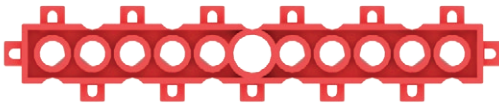

Bloc 1x11 (1)



Bloc de îmbinare (2)

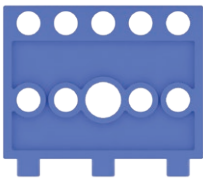

Suport de motor (1)

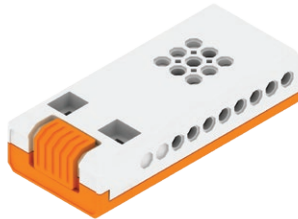

Acumulator 1 (1)



Acumulator 2 (2)



Motor 2 (1)



Cablu de conectare (3)

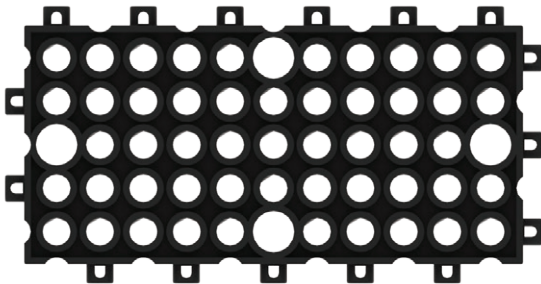

Bloc 5x11 (4)

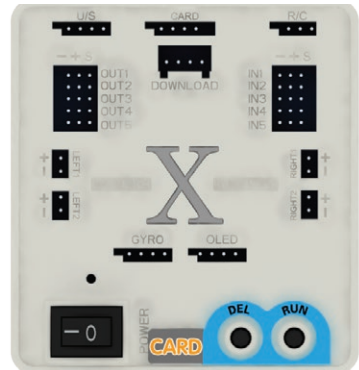

Placă de bază MRT-Card (1)

M-shaft Ax M (2)

L-shaft Ax L (1)

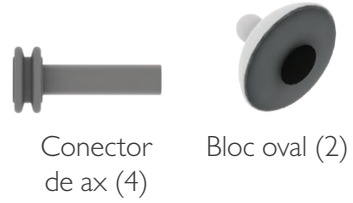

Bloc N 1x7 (1)



Cauciuc roșu de ax (6)



Piuliță (2)



Îmbinare de axuri (3)



Bloc N 1x11 (2)



Bloc N 1x5 (2)



Angrenaj L (2)



Angrenaj M (2)



Angrenaj S (1)



Nit dublu (1)

01

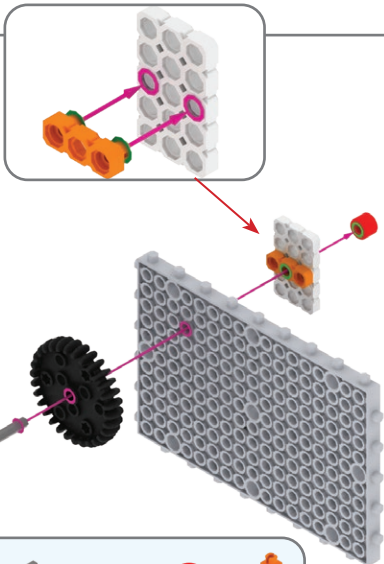

M

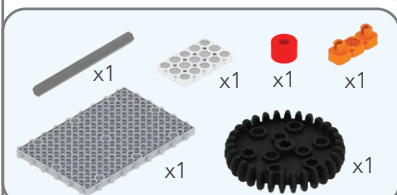

1:1

02

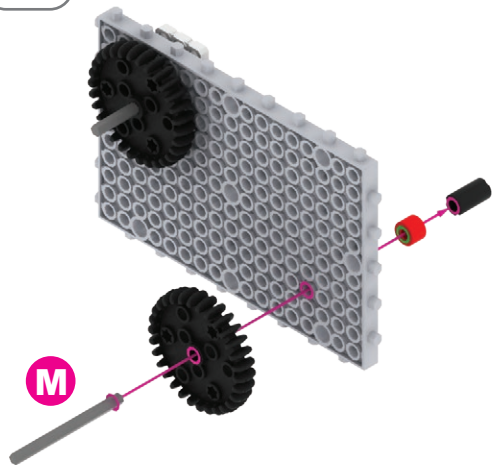

M

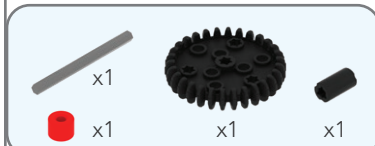

1:1



03

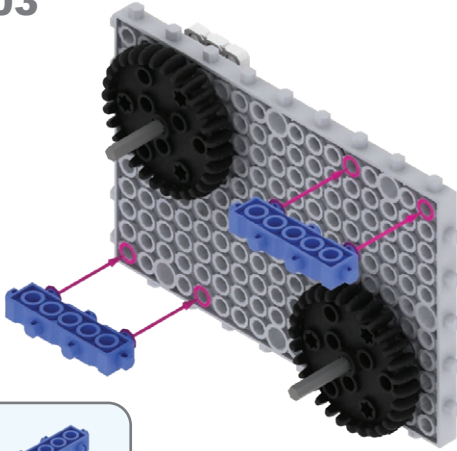

04

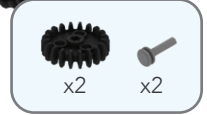
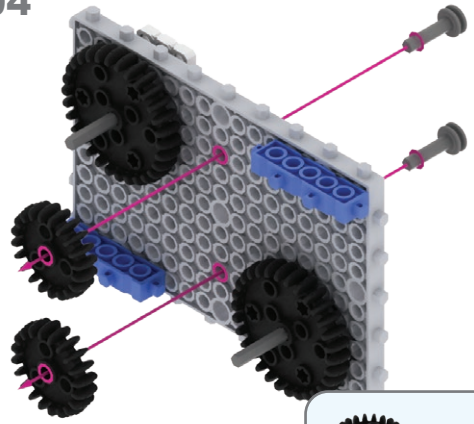

05

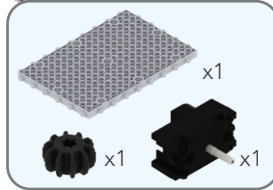
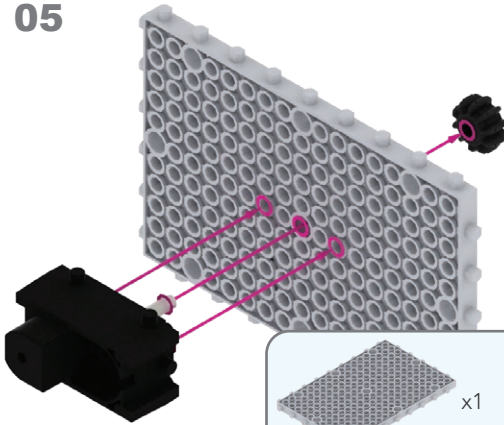

06

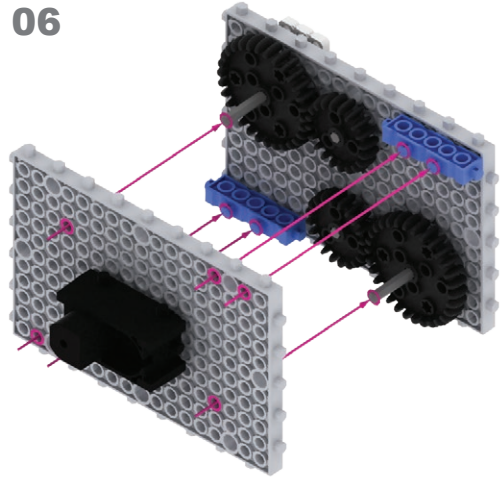

07

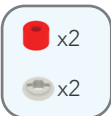
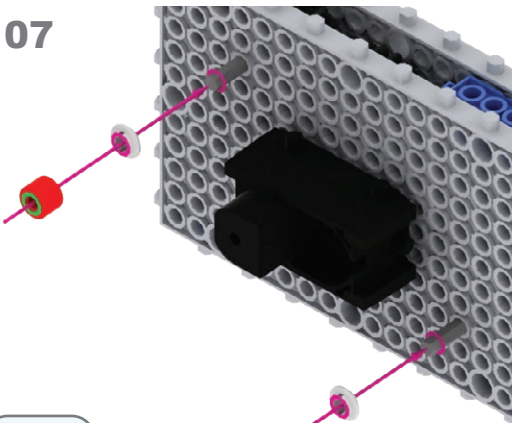

08

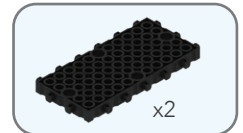
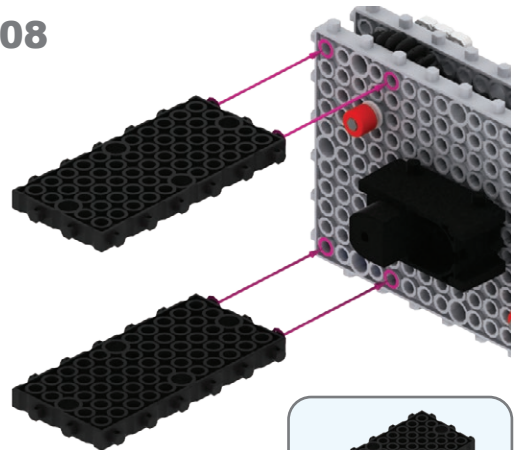

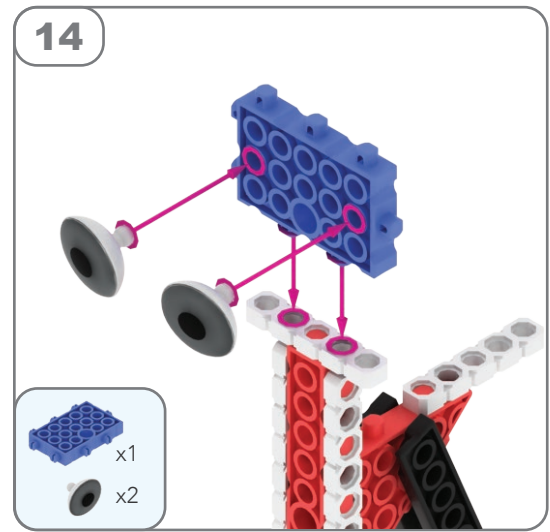
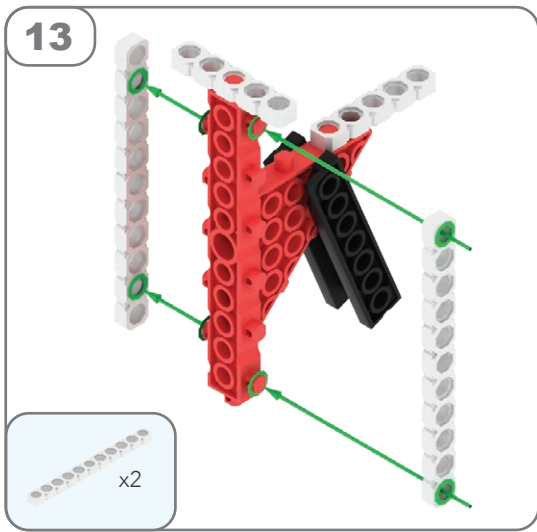
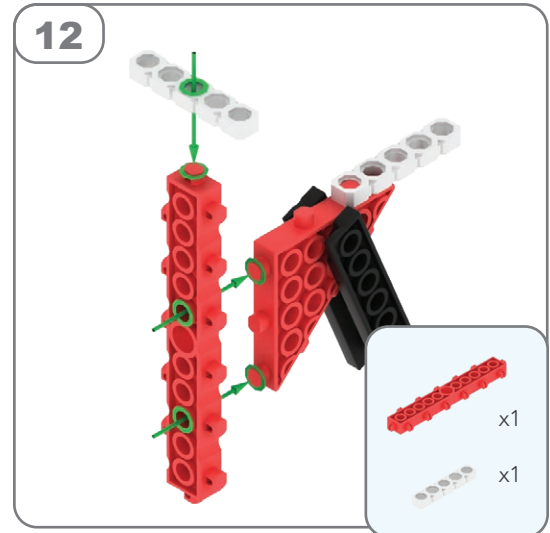
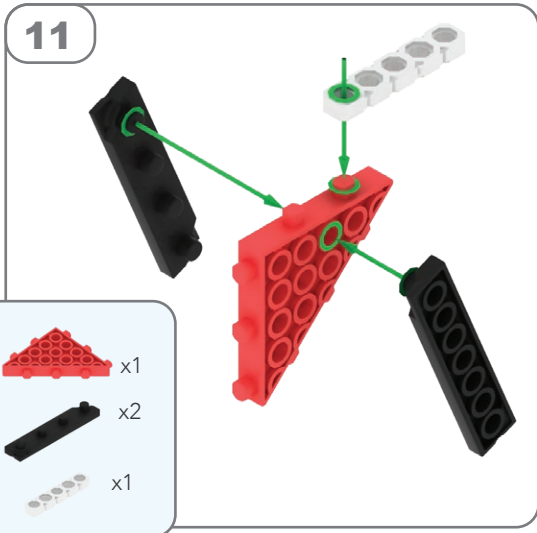
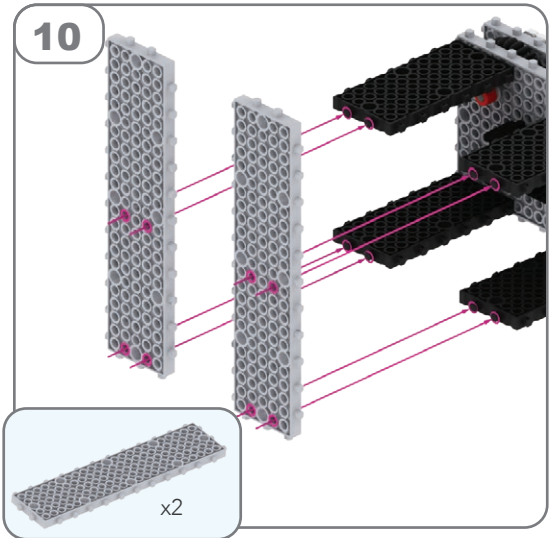
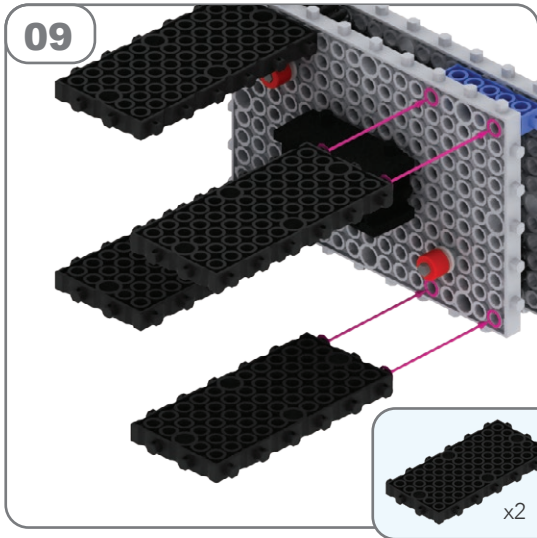

15

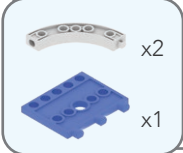
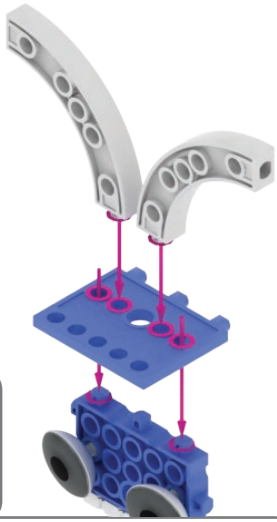

16



17

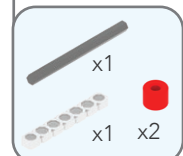
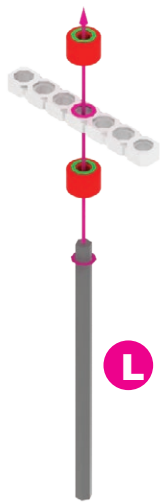

18

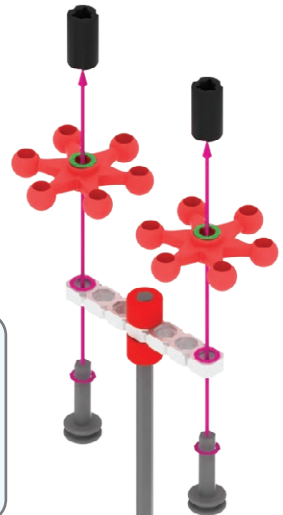

19

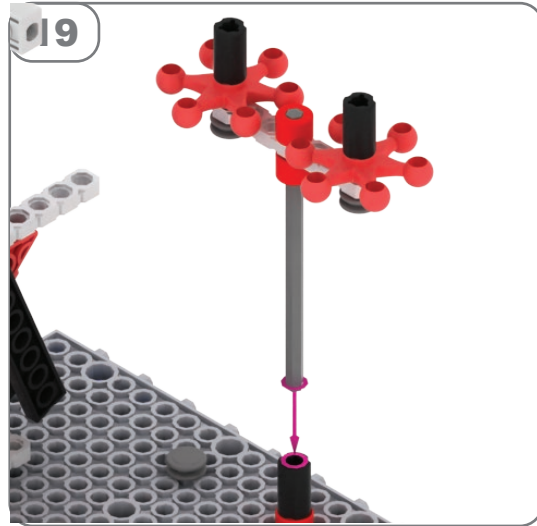

20

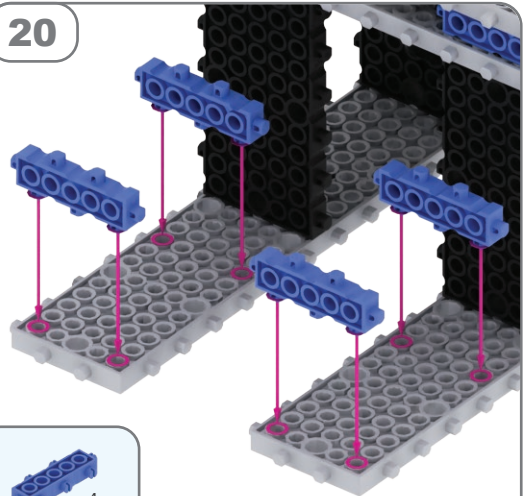



21

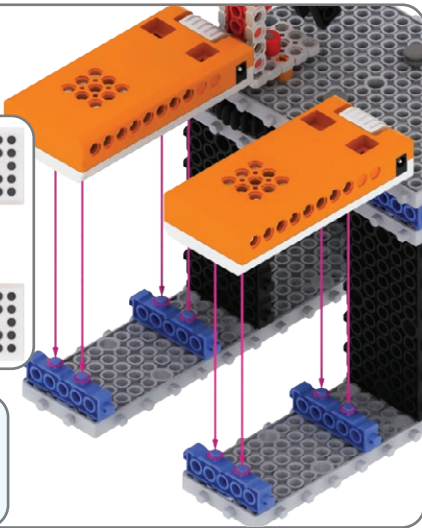
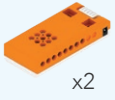
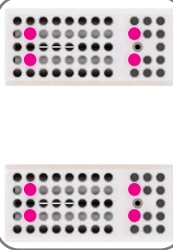

22

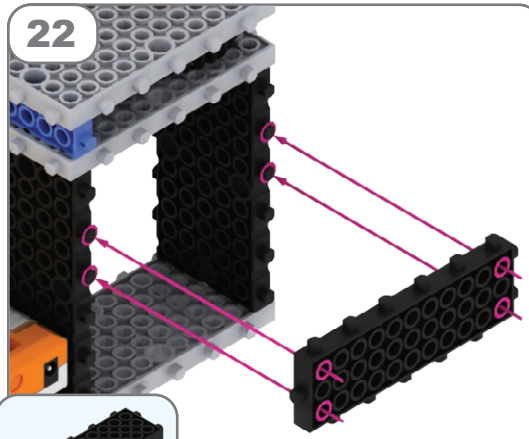
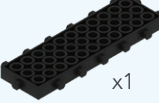

23

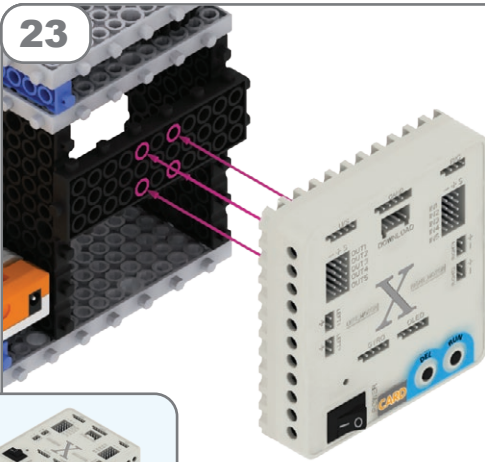

24

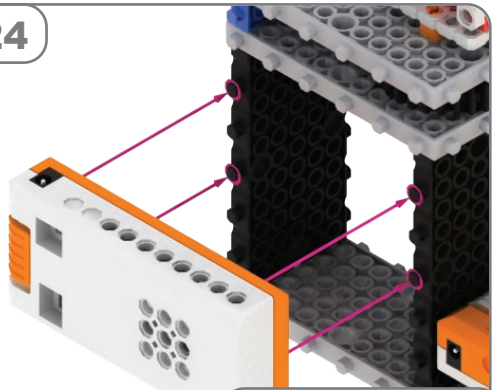
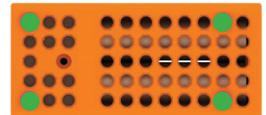

**OK**

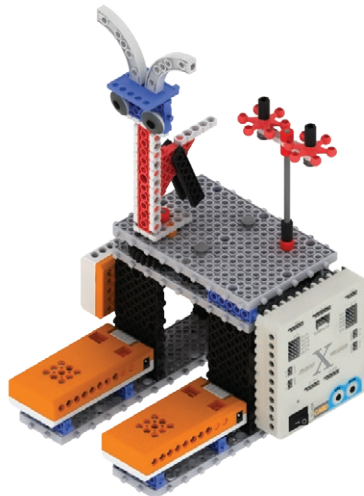

## Cum se conectează?

Triunghiul ▲ trebuie să corespundă cu ▲ conectorului de cablu de pe cititorul de carduri

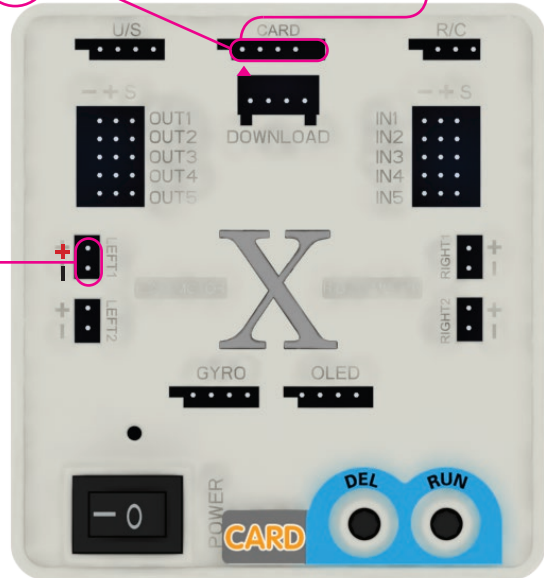
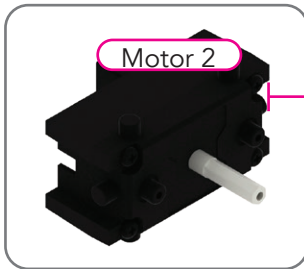

Pentru o descriere mai în detaliu, consultă secțiunea „Sfaturi pentru o bună asamblare” din revistă.



Forward



Backward



Cycle start (all time)



Cycle end

Programare:

1. Cycle start (all time)
2. Forward
3. Delay 1 sec
4. Delay 1 sec
5. Delay 1 sec
6. Backward
7. Delay 1 sec
8. Delay 1 sec
9. Delay 1 sec
10. Cycle end

Consultă secțiunea „Învață să programezi” din revistă: acolo vei găsi o explicație mai detaliată și mai multe exemple de programare.



Delay 1 sec